



## testo 770

Clamp meter

Instruction manual





# 1 Contents

1	Contents .....	3
2	Observe prior to use! .....	5
3	Safety instructions .....	5
4	Intended use .....	6
5	Overview .....	7
5.1	Display and control elements .....	7
5.2	LC display .....	8
5.3	Control key functions .....	9
5.4	Rotary switch functions .....	9
5.5	Further functions .....	10
5.5.1	Bluetooth® (testo 770-3 only) .....	10
5.5.2	HOLD .....	10
5.5.3	MAX/MIN/AVG .....	10
5.6	Explanation of icons .....	11
6	Operating the instrument .....	11
6.1	Switching the instrument on .....	12
6.2	Switching the background illumination on/off .....	12
6.3	Switching the instrument off (automatically/manually) .....	13
6.3.1	Automatically .....	13
6.3.2	Manually .....	13
6.4	Using testo 770-3 with testo Smart Probes App .....	13
6.4.1	Establishing Bluetooth® connection (testo 770-3) .....	13
6.4.2	Transmitting readings .....	13
6.4.3	Overview of the App operating controls .....	14
7	Carrying out a measurement .....	14
7.1	Preparing for measurement .....	14
7.2	Current measurement .....	14
7.2.1	Measuring A AC or A DC .....	15
7.2.1.1	Automatic measuring mode .....	15
7.2.2	Manual measuring mode .....	15
7.2.3	Measuring $\mu$ A AC or $\mu$ A DC (testo 770/-2/-3 only) .....	15
7.2.3.1	Automatic measuring mode .....	15
7.2.3.2	Manual measuring mode .....	15
7.3	Voltage measurement .....	16
7.3.1	Automatic measuring mode .....	16
7.3.2	Manual measuring mode .....	16

7.4	<b>Measuring resistance, capacitance, continuity and diode test</b> .....	16
7.4.1	testo 770-1/-2 .....	16
7.4.1.1	Manual measuring mode .....	16
7.4.2	testo 770-3.....	17
7.4.2.1	Automatic measuring mode .....	17
7.4.2.2	Manual measuring mode .....	17
7.5	<b>Power measurement (testo 770-3 only)</b> .....	17
7.6	<b>Frequency measurement</b> .....	18
7.7	<b>Temperature measurement (optional) (testo 770-2/-3 only)</b> .....	18
7.7.1	Carrying out temperature measurement...	18
7.8	<b>Inrush current (INRUSH)</b> .....	18
8	<b>Service and maintenance</b> .....	19
8.1	<b>Replacing the batteries</b> .....	19
8.2	<b>Maintenance</b> .....	19
8.3	<b>Calibration</b> .....	20
8.4	<b>Storage</b> .....	20
8.5	<b>Cleaning</b> .....	20
9	<b>Technical data</b> .....	20
9.1	<b>General technical data</b> .....	20
9.2	<b>More technical data</b> .....	21
9.2.1	testo 770-1/-2 .....	21
9.2.2	testo 770-3.....	22
9.3	<b>Bluetooth module (testo 770-3 only)</b> .....	24
10	<b>Tips and assistance</b> .....	25
10.1	<b>Questions and answers</b> .....	25
10.2	<b>Accessories and spare parts</b> .....	25
11	<b>Protecting the environment</b> .....	25
	<b>Approval and Certification</b> .....	26

## 2 Observe prior to use!

- The instruction manual contains information and instructions which are necessary for operating and using the instrument safely. Before using the instrument, read the instruction manual carefully and comply with all aspects of it. Keep this document to hand so that you can refer to it when necessary. Forward this documentation to any subsequent users of the instrument.
- If the manual is not followed, or if you fail to observe the warnings and instructions, there is a risk of fatal injury to the user and damage to the instrument.

## 3 Safety instructions

- The instrument may only be used by trained personnel. Please observe the Employers' Liability Insurance Association provisions for health and safety at work.
- Before handling any wires or components, you must first ensure that all power has been shut off to the circuit. It is also recommended to recheck the wires or components for power using a voltage tester.
- According to the description of DIN VDE 0104, this instrument is not approved for **determining the absence of voltage**.
- In order to prevent electrical shock, take safety precautions when working with voltages greater than 60 V (35 V DC) or 25 V (16 V rms AC). Use personal safety equipment such as approved rubber gloves, face protection and flame-resistant clothing.
- Measure a known voltage first to make sure the instrument operates correctly.
- The measuring instrument may only be used with a maximum voltage of 600 V.
- Measurements that are dangerously close to electrical installations must only be carried out under the direction of a qualified electrician.
- The instrument may only be touched at the designated grip areas, the display elements must not be covered.
- Always ensure that your measuring instrument is in proper working order to maintain operating safety. Decommission the instrument if the following issues apply:
  - has obvious indications of damage
    - cracks on the housing
    - defective test leads
    - leaking batteries
  - will no longer carry out the required measurements
  - was stored for too long in unfavourable conditions
  - was exposed to mechanical stresses during transport.
- Prevent the instrument from being exposed to extreme heat by direct prolonged sunlight. This is the only way to ensure that the instrument functions perfectly and has a long service life.
- If the instrument needs to be opened, this should only be carried out by an expert. Before being opened, the instrument must be switched off and isolated from all electrical circuits.
- Maintenance work that is not described in this documentation must only be carried out by trained service technicians.
- If the instrument is modified in any way, operational safety can no longer be guaranteed.
- Modifications or alterations to the instrument will result in warranty or guarantee claims against the manufacturer.
- It is not permitted to use the instrument in an explosive environment.

## 4 Intended use

---

- Before and after use, always check that the instrument is in peak working order. To do this, test the instrument at a known current source.
- High-frequency electromagnetic fields (HF) can influence the measurement result and result in the wrong information being displayed. This influence is temporary and will not damage the measuring instrument in any way. As soon as the measuring instrument is removed from the influencing HF field, its original accuracy will be re-established. Known sources of these high-frequency electromagnetic fields are radio or mobile telephony equipment, for example. If this type of equipment should influence the measuring instrument, switch it off or increase the distance between the equipment and the measuring instrument.
- The instrument must not be used while its battery compartment is open.
- Batteries must be checked before use and changed if necessary.
- Storage areas must be dry.
- If there is any battery leakage, the instrument must no longer be used until it has been checked by our Customer Service.
- The battery acid (electrolyte) is highly alkaline and electrically conductive. Risk of acid burn! If the battery acid comes into contact with your skin or clothing, thoroughly rinse the areas affected immediately with plenty of water. If battery acid gets into your eyes, rinse them immediately with plenty of water and seek medical advice.

## 4 Intended use

The instrument may only be used under the conditions and for the purpose for which it was designed:

- The instrument conforms to measurement category CAT IV with a rated voltage of 600V to earth.  
Measurement category CAT IV is for use at the source of voltage installations, e.g. building connection, main fuse, meter.

The instrument may only be used in the fields of application described in the instruction manual. Any other application is considered improper and untested usage, and can result in accidents or damage to the instrument. Any misuse will result in the complete invalidation of any warranty or guarantee claims against Testo.

The manufacturer is not responsible for any damage to property or personal injury resulting from the following:

- Failure to observe the instruction manual
- Instrument modifications not approved by the manufacturer
- The use of spare parts not approved by the manufacturer
- Use under the influence of alcohol, drugs or medication

The instrument must not be used for the following circumstances:

- In potentially explosive atmospheres: the instrument is not explosion-proof!
- When there is rain or other precipitation: risk of electric shock!

## 5 Overview

### 5.1 Display and control elements





- 1 Control keys
- 2 LC display
- 3 Clamp trigger
- 4 Clamp/hook
- 5 HOLD key
- 6 Rotary switch
- 7 Grip area
- 8 On the rear: Battery compartment
- 9 Input jack for voltage, resistance, continuity, capacitance, diode, frequency and  $\mu\text{A}$  measurements
10. Ground/COM jack for all measurements from point 9

## 5.2 LC display



- 1 Direct current/voltage
- 2 Alternating current/voltage
- 3 Inrush current measurement
- 4 Zeroing enabled in DC current measuring mode
- 5 **AUTO** mode is the default setting in all measuring modes
- 6 Power factor
- 7 Dangerous voltage, AC  $\geq 33$  V, DC  $\geq 70$  V
- 8 Bluetooth® enabled (testo 770-3 only)
- 9 Maximum, minimum, average measurement
- 10 Alarm off
- 11 **Hold** is activated, LC display holds the current reading
- 12 Battery capacity display

Display	Feature
No Symbol	Battery capacity 100 – 30%
	Battery capacity 30 - 15%
	Battery capacity 15 - 2%
 flashes and acoustic signal emitted	Battery capacity 2 – 0%, instrument switches off automatically







- 13 Automatic power-off function is activated
- 14 Measuring units
- 15 Diode test and continuity
- 16 Measuring units
- 17 Analog display (testo 770-3 only)
- 18 Indication of polarity in bar chart (testo 770-3 only)











### 5.3 Control key functions



The clamp meter features a rotary switch, as well as 6 control keys, which respond to a brief or a long keypress.

In the default setting, the instrument is in **AUTO** mode when voltage, current, RCDC (resistance, capacitance and diode with continuity) is being measured.

Key	Brief keypress function (<1 s)	Long keypress function (>2 s)
 Zero adjustment	Zeroing when measuring DC current	Exit zero adjustment
 Select	Switches between the manual sub-modes of the selected measurement.	Back to <b>AUTO</b> mode
 Min/Max	Switches between MAX, MIN and AVG functions	Switch off recording mode
 Inrush	If position <b>A</b> is selected, the instrument switches to inrush mode. Reset the inrush measurement if a measurement is already shown on the LC display.	Switches back to the mode most recently activated before <b>INRUSH</b> was selected.
 Illumination	Background illumination on/off	
 (testo 770-3) Illumination/ Bluetooth	Background illumination on/off	Bluetooth on/off



### 5.4 Rotary switch functions

Selection	Function
 Switch off	Switch the instrument off.
 Current	Activates automatic mode for current, choose between AC/DC. Manual selection of AC/DC with  .
 Voltage	Activates automatic mode for voltage between AC and DC measurement via the test leads and jacks. Manual selection of AC/DC with  .
 RCDC control	Automatic mode for resistance, continuity, capacitance and diode test. Manual selection of AC/DC with  .
 testo 770-3 only	Activates the mode for power measurement. Manual selection of active, reactive and apparent power, as well as power measurement for direct current/voltage with  .

Selection	Function
 testo 770-2/-3 only	Automatic mode for µA measurement. Manual selection of AC/DC with  .

## 5.5 Further functions

### 5.5.1 Bluetooth® (testo 770-3 only)

- > Enable Bluetooth®: press and hold down  and turn the rotary switch from **[OFF]** to a function. Then release .
- > Disable Bluetooth®: turn rotary switch to **[OFF]**.

### 5.5.2 HOLD

- > Activate function: press **[HOLD]** <1 s.
  - the current reading is recorded and **HOLD** is shown on the LC display.
- > Exit function: press **[HOLD]** <1 s.
  - the current measurement is displayed.





The Hold function can be used from all measuring modes.

### 5.5.3 MAX/MIN/AVG

 allows for switching between maximum, minimum and the periodic display of AVG values.



This function is disabled in the default setting.



- > Activate function: press  <1 s.
  - Max value is displayed.
- > Display min value and periodic display of AVG values:
  - press  <1 s each time.
- > Exit function: press  >2 s or **[HOLD]**.





This function can be activated in all measuring modes (this function is not available at capacitance measurement with testo 770-1 and testo 770-2).















When pressing  in **AUTO AC/DC** voltage mode or **AUTO AC/DC** current measurement mode, the instrument retains the last-selected AC/DC setting. In all other operating states, you can select what you need by briefly pressing the  key or via the rotary switch itself:



- Voltage measurement and measurement with a thermocouple adapter: select 
- Current measurement: select 

- Resistance, continuity, diode and capacitance measurement: select 
- µA measurement: select  (testo 770-3 only).
- Power measurement: select  (testo 770-3 only).

## 5.6 Explanation of icons



Icon	Meaning
	<b>Attention!</b> Warning about a danger spot, refer to instruction manual
	<b>Caution!</b> Dangerous voltage, risk of electric shock
	Application around and removal from HAZARDOUS LIVE conductors is permitted.
	Continuous double or reinforced insulation complies with category II DIN EN 61140 / IEC 536
	The product is certified for the US and Canadian markets, in accordance with the applicable American and Canadian standards.
	Compliance mark for ACMA (Australian Communications and Media Authority) guidelines.
	This product has been tested to the requirements of CAN/CSA-C22.2 No. 61010-1, second edition, including Amendment 1, or a later version of the same standard incorporating the same level of testing requirements.
	KC (South Korea)
	Japan certification
	ANATEL (Brazil)
	Bluetooth testo 770-3 only
	Conformity mark, verifies compliance with the valid EU Directives: EMC Directive (2014/30/EU) with the EN 61326-1 standard, Low-Voltage Directive (2014/35/EU) with the EN 61010-1 standard
	The instrument complies with the WEEE Directive (2012/16/EU)

## 6 Operating the instrument

Different measuring modes can be selected via the rotary switch. When the instrument is in voltage mode , it automatically detects the range and the type of measurement, AC or DC. When the instrument is in current mode , it automatically switches between AC and DC accordingly.

## 6 Operating the instrument

---

When the rotary switch is at the  position, the instrument automatically detects the appropriate measurement. If the instrument is switched to power mode , it measures active, reactive and apparent power together with the power factor (for sinusoidal signals).



All the available measuring modes can also be selected manually.

### Magnetic suspension system (accessory)



You can use the magnetic suspension system, which is available as an accessory, order number 0590 0001, to attach the testo 770 to metal surfaces.

The suspension system's magnet must not come anywhere near the clamp meter during the measurement (see graphic). Automatic adjustment of the measuring range could be influenced as a result.



Do not hang the testo 770 higher than 2m.



#### WARNING

Magnetic field

**May be harmful to those with pacemakers.**

> Keep a minimum distance of 15 cm between pacemaker and instrument.

#### CAUTION

Magnetic field

**Damage to other devices!**

> Keep a safe distance away from products that could be damaged by the effects of magnetism (e.g. monitors, computers or credit cards).

## 6.1 Switching the instrument on

- > Switch on: turn the rotary switch to the required measuring mode.
- The instrument switches on.

## 6.2 Switching the background illumination on/off

- > To switch on/off: briefly press the  key.

The background illumination switches off automatically within 1 minute.



It is possible to switch the background illumination on/off in all measuring modes.

## 6.3 Switching the instrument off (automatically/manually)

### 6.3.1 Automatically

The automatic power-off function (APO) is always enabled as a default setting and is shown on the LC display as **APO**. If no control key is pressed within 15 min, the instrument switches off automatically. If necessary, the automatic power-off function (APO) can be turned off.

- > Disable power-off function: press the **[HOLD]** key and turn the rotary switch from the OFF position to a different position.



Once the instrument has switched off, the power-off function is reset to the default setting.

---

### 6.3.2 Manually

- > Switch off: turn the rotary switch to the **[OFF]** position.



## 6.4 Using testo 770-3 with testo Smart Probes App

### 6.4.1 Establishing Bluetooth® connection (770-3)

You need a tablet or smartphone with the testo Smart Probes App already installed on it to be able to establish a Bluetooth connection.

You can get the App for iOS instruments in the App Store or for Android instruments in the Play Store.

Compatibility:

- requires iOS 8.3 or newer / Android 4.3 or newer
- requires Bluetooth 4.0
- tested with the following smartphones / tablets:  
[www.testo.com/smartprobesmanuals.html](http://www.testo.com/smartprobesmanuals.html)
- ✓ The testo Smart Probes App is installed on your mobile terminal device and ready for use.
- > Enable Bluetooth®: press and hold down  and turn the rotary switch from **[OFF]** to a function. Then release .
- **CONN** appears in the display. If the Bluetooth® connection is established,  appears in the display and the instrument changes to the set measuring mode.
- > Disable Bluetooth®: Turn rotary switch to **[OFF]**.

### 6.4.2 Transmitting readings

- ✓ testo 770-3 is switched on and connected to your mobile terminal device via Bluetooth.
- The current readings are automatically displayed in the App.

### 6.4.3 Overview of the App operating controls

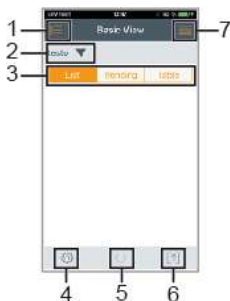

- 1 Choice of applications.
- 2 Display of connected instruments.
- 3 Switch between views (list, graphic, table)
- 4 Settings for measurement. (The menu adjusts depending on the instrument connected and the application selected)
- 5 Restarts the measuring value recording in graph and table format.
- 6 Export of the readings
- 7 Menu options

## 7 Carrying out a measurement

### 7.1 Preparing for measurement

Prior to every measurement, please ensure that the instrument is in perfect condition:

- For example, keep an eye out for broken housing or leaking batteries.
- Always carry out a function test before using the instrument, see below.
- Check that the instrument is functioning perfectly (for example at a known voltage source) before and after every test.
- If the safety of the user cannot be guaranteed, the instrument must be switched off and secured to prevent unintentional usage.



When connecting the test leads to the test object, always connect the common test lead (**COM**) to the test object first of all. When disconnecting the test leads, always disconnect the +/- phase test lead first of all.

### 7.2 Current measurement



#### WARNING

**Serious risk of injury to the user and/or destruction of the instrument while measuring current.**

> Measuring circuit must be de-energized.



The measuring instrument may only be used in circuits up to a maximum voltage of 600V. The nominal cross-section of the connection cable must be taken into account in order to ensure safe connection (e.g. via crocodile clips).



Strong RFI interference and / or open leads when measuring A AC may result in unstable display readings.

## 7.2.1 Measuring A AC or A DC

### 7.2.1.1 Automatic measuring mode

1. Switch instrument on: set rotary switch to .
  - The instrument switches on.
  - The instrument is in **AUTO A** mode.
2. Enclose the live conductor and centre it in the jaws.
  - The instrument automatically detects the **A AC** or **A DC** mode.
  - The measured value is shown on the LC display.



For measurements below 3.0 A AC, the automatic AC/DC detection might not work. If that happens, set AC/DC manually.

## 7.2.2 Manual measuring mode

✓ Instrument is in automatic measuring mode **AUTO A**

1. Exit **AUTO A** measuring mode: press <1 s.
2. Switch between **A AC** and **A DC**: press <1 s.
  - The measured value is shown on the LC display.

Switch to automatic measuring mode: press >1 s.

- The instrument is in automatic measuring mode when **AUTO** is illuminated on the LC display.

## 7.2.3 Measuring $\mu$ A AC or $\mu$ A DC (testo 770/-2/-3 only)

### 7.2.3.1 Automatic measuring mode

1. Switch instrument on: set rotary switch to .
  - The instrument switches on.
  - The instrument is in **AUTO  $\mu$ A** mode.
2. Connect test leads: black test lead to black jack, red test lead to red jack. Then connect test leads to the test object.
  - The instrument automatically detects the  **$\mu$ A AC** or  **$\mu$ A DC** mode.
  - The measured value is shown on the LC display.

### 7.2.3.2 Manual measuring mode

✓ Instrument is in automatic measuring mode **AUTO  $\mu$ A**.

1. Exit **AUTO  $\mu$ A** measuring mode: press <1 s.
2. Switch between  **$\mu$ A AC** and  **$\mu$ A DC**: press <1 s.
  - The measured value is shown on the LC display.

Switch to automatic measuring mode: press >1 s.

- The instrument is in automatic measuring mode when **AUTO** is illuminated on the LC display.

### 7.3 Voltage measurement

---



When measuring AC voltage, the frequency is measured at the same time and shown in the relevant row on the LC display.

---

#### 7.3.1 Automatic measuring mode

1. Switch instrument on: set rotary switch to .
    - The instrument switches on.
    - The instrument is in **AUTO V** mode.
  2. Connect test leads: black test lead to black jack, red test lead to red jack. Then connect test leads to the test object.
- 





The instrument features a built-in zero crossing detector. When the measured signal (voltage or current) indicates zero crossings, the instrument automatically switches to AC measuring mode. If continuity is indicated, the instrument switches to DC measuring mode.

---

- The measured value is shown on the LC display.

#### 7.3.2 Manual measuring mode

- ✓ Instrument is in automatic measuring mode **AUTO V**.
1. Exit **AUTO V** measuring mode: press  <1 s.
  2. Switch between **V AC** and **V DC**: press  <1 s.
    - The measured value is shown on the LC display.
  3. Switch to automatic measuring mode: press  >1 s.
    - The instrument is in automatic measuring mode when **AUTO** is illuminated on the LC display.

### 7.4 Measuring resistance, capacitance, continuity and diode test



#### WARNING

Serious risk of injury to the user and/or destruction of the instrument during resistance testing.

> Test object must be de-energized.

---



External voltages will distort the measurement result.

---

#### 7.4.1 testo 770-1/-2

##### 7.4.1.1 Manual measuring mode

1. Switch instrument on: set rotary switch to .
  - The instrument is switched on.



2. Connect test leads: black test lead to black jack, red test lead to red jack. Then connect test leads to the test object.
  - The instrument is in  $\Omega$  measuring mode.
3. Switch between resistance, capacitance, continuity and diode test:  
press **[SELECT]** <1 s.
  - The measured value is shown on the LC display.

### 7.4.2 testo 770-3

#### 7.4.2.1 Automatic measuring mode

---



Automatic detection for resistance/capacitance in the following range:

- 0.0 ohms to 6.000 mohms
- 0.500 nF to 600.0  $\mu$ F

Change to manual measuring mode for the remaining measuring range.

---

1. Switch instrument on: set rotary switch to 
  - The instrument is switched on.
2. Connect test leads: black test lead to black jack, red test lead to red jack. Then connect test leads to the test object.
  - The instrument is in **AUTO RCDC** measuring mode.
  - The instrument detects resistance, continuity, diode and capacitance and automatically adjusts the measuring range.
  - The measured value is shown on the LC display.

#### 7.4.2.2 Manual measuring mode

3. Disable **AUTO RCDC** measuring mode: press **[SELECT]** <1 s.
4. Switch between resistance, capacitance, continuity and diode test:  
press **[SELECT]** <1 s.
  - The measured value is shown on the LC display.
- > Switch back to **AUTO** mode: press **[SELECT]** >2 s.

## 7.5 Power measurement (testo 770-3 only)

For the power measurement, two measurements are carried out at the same time. The voltage of the measurement object is measured via the **COM** jack, **V** input jack and using two test leads. The current of the measurement object must be measured using the clamp meter. From these two factors, the instrument automatically calculates the different types of power, as well as the power factor.

1. Switch instrument on: set rotary switch to 
  - The instrument switches on.
  - The instrument is in the mode for power measurement with alternating current/voltage
2. Enclose the live conductor and centre it in the jaws.
3. Connect test leads: black test lead to black jack, red test lead to red jack. Then connect test leads to the test object.
4. The instrument displays the active power in w(atts) and the power factor (PF).

## 7 Carrying out a measurement

---



The instrument requires approx. 5 s for the reading to be displayed. An updated reading is displayed after approx. 5 s.

5. Switch between active power, apparent power, reactive power and power measurement for direct current/voltage: press **SELECT** <1 s.

### 7.6 Frequency measurement

The frequency is displayed automatically during an A AC or V AC measurement.



The following minimum values are necessary for correct display of frequency with voltage and/or current measurement:

Voltage: 200 mV

Current: 1.5% of the measuring range

### 7.7 Temperature measurement (optional) (testo 770-2/-3 only)

A thermocouple adapter (0590 0021) is optionally available for measuring temperature. Before using the thermocouple adapter, please carefully read through the relevant section relating to the thermocouple adapter in the documentation. Familiarize yourself with the product before using it. Pay particular attention to the safety instructions and warning advice in order to prevent injuries and damage to the product.

In this section, it is assumed that you are familiar with the contents of the documentation relating to the thermocouple adapter.

#### 7.7.1 Carrying out temperature measurement



- ✓ A thermocouple is attached to the thermocouple adapter.
1. Switch instrument on: set rotary switch to .
    - The instrument switches on.
    - The instrument is in **AUTO V** mode
  2. Connect the thermocouple adapter to the instrument: plug the adapter into the jack. Ensure correct polarity!
    - The thermocouple adapter switches on automatically.
  3. Activate temperature measurement: press **ZERO** >2 s.
    - The measured values are shown on the LC display in °C and °F.

### 7.8 Inrush current (INRUSH)



The inrush function is an approximation function. This means that readings can differ from one another.

1. Switch instrument on: set rotary switch to .
  - The instrument switches on.
  - The instrument is in **AUTO A** mode.
2. Enclose the live conductor and centre it in the jaws.

3. Activate inrush current calculation: press [  ] <1 s.
  - The measured value is shown on the LC display.
4. Restart inrush current calculation: press [  ] <1 s.
  - The measured value is shown on the LC display.
5. Exit inrush current calculation and switch back to **AUTO** mode: press [  ] >2 s.

## 8 Service and maintenance

### 8.1 Replacing the batteries

The batteries need to be replaced when the battery icon appears on the LC display.

- ✓ The instrument is switched off.
1. Disconnect the instrument from the test leads and make sure that the instrument is not enclosing any live cable.



2. Using a screwdriver, unscrew the two metal screws (1, 2) on the battery compartment until the battery compartment cover can be removed. Do not unscrew the screws completely.
3. Remove the spent batteries.
4. Insert new batteries, type AAA / IEC LR03 (1.5 V), ensuring correct polarity.
5. Put the battery compartment cover back on and screw down.

### 8.2 Maintenance

When operated in accordance with the instruction manual, the instrument does not require any particular maintenance.

If a malfunction occurs during operation, the ongoing measurement should be stopped immediately. Send the instrument to Testo-Industrial-Services GmbH for checking.

### 8.3 Calibration

In order to maintain the specified accuracy of the measurement results, Testo recommends calibrating the instrument once a year. Send the instrument to Testo Service for calibration.

### 8.4 Storage

- Store the instrument in dry, closed rooms.
- > If the instrument is not in use for a significant period of time: remove the batteries in order to prevent any danger or damage due to any potential leaking of the batteries.

### 8.5 Cleaning

Before cleaning, the instrument must be switched off and disconnected from external voltages or from other connected instruments (test specimen, control units, etc.).

- > Wipe the instrument with a damp cloth and a small amount of mild household detergent.

Never use any harsh cleaning agents or solvents to clean the instrument! After being cleaned, the instrument must not be used until it has completely dried.

## 9 Technical data

### 9.1 General technical data

Feature	Values
Ambient operating temperature	-10 °C to +50 °C
Ambient storage temperature	-15 °C to +60°C
Humidity	0 to 80% RH
Operating altitude	Up to 2000 m
Measurement category	CAT IV 600 V / CAT III 1000 V
Level of contamination	2
Protection class	IP 40
Power supply	3 x 1.5 V (AAA / IEC LR03)
Battery status display	Batt. icon appears from <3.9 V
Display	3 3/4 digit, LC display
Display range	testo 770-1/-2: 4000 digits testo 770-3: 6000 digits
Polarity indicator	automatic
Overload protection for $\mu$ A current measurement	high-impedance (testo 770-2/-3 only)
Inrush current (INRUSH)	100ms
Dimensions (H x W x D)	249 x 96 x 44 mm
Weight	378 g

Feature	Values
Safety standards	WEEE 2012/16/EU, EMC 2014/30/EU, EN 61326-1, Low-Voltage Directive 2014/35/EU with the standard EN 61010-2-032, insulation complies with category II IEC 536 / DIN EN 61140

## 9.2 More technical data

### 9.2.1 testo 770-1/-2

Feature	Measuring range <sup>1</sup>	Resolution	Accuracy
DC voltage	4.000 V 40.00 V 400.0 V 600 V	1 mV 10 mV 100 mV 1 V	± (0.8% of meas. val. + 3 digits)
AC voltage <sup>2, 3, 4</sup>	4.000 V 40.00 V 400.0 V 600 V	1 mV 10 mV 100 mV 1 V	± (1.0% of meas. val. + 3 digits)
DC current - jaws [A] - jack [µA] (testo 770-2)	40 A 400 A 400 µA	0.01 A 0.1 A 0.1 µA	± (2.0 % of meas. + 5 digit) ± (2.0% of meas. val. + 5 digits) ± (1.5% of meas. val. + 5 digits)
AC current <sup>21</sup> - jaws [A] <sup>5</sup> - jack [µA] (testo 770-2) <sup>20,22</sup>	40 A 400 A 400 µA	0.01 A 0.1 A 0.1 µA	± (2.0 % of meas. + 5 digit) ± (2.0% of meas. val. + 5 digits) ± (1.5% of meas. val. + 5 digits)
Resistance	400.0 Ohm 4.000 kOhm 40.00 kOhm 400.0 kOhm 4.000 MOhm 40.00 MOhm	0.1 Ohm 1 Ohm 10 Ohm 100 Ohm 1 kOhm 10 kOhm	± (1.5% of meas. val. + 3 digits)
Continuity alarm	<0 to 30 Ohm		

<sup>1</sup> The lower measuring ranges are only specified from 5% (does not apply to DC current / AC current measurements with the current probe)

<sup>2</sup> Signal bandwidth 40 Hz to 1 kHz

<sup>3</sup> In the case of a mixed signal (AC + DC), only the purely AC component is taken into account

<sup>4</sup> As the frequency increases (over 400 Hz), the accuracy deteriorates +/- (2.5% of m.v. + 3 digits) for 400Hz to 750Hz / +/- (5.0% of m.v. + 3digits) for 750Hz to 1000Hz

<sup>5</sup> Frequency of AC current up to 400 Hz

## 9 Technical data

Feature	Measuring range <sup>1</sup>	Resolution	Accuracy
Diode test	yes (0 to 2.5 V)		
Capacity	51.20 nF <sup>6</sup>	0.01 nF	± 10% typically
	512.0 nF	0.01 nF	± (1.5% of meas. val. + 5 digits)
	5.120 µF	0.001 µF	± (1.5% of meas. val. + 5 digits)
	51.20 µF	0.01 µF	± 10% typically
	100.0 µF (15 s) <sup>7</sup>	0.1 µF	± 10% typically
Temperature with adapter (testo 770-2) <sup>8</sup>	-20 to 500 °C	0.2 °C	-20 to 0 °C: +/- 2 °C 0 °C to 100 °C: +/- 1 °C 100 °C to 250 °C: +/- 1.5% >250 °C: +/- 2%

Figures correspond to +23 °C ± 5 °C at <80% rel. humidity. Temperature coefficient: 0.15 x specified accuracy per 1 °C (<18 °C and >28 °C)

### 9.2.2 testo 770-3

Feature	Measuring range <sup>9</sup>	Resolution	Accuracy
DC voltage	6.000 V 60.00 V 600.0 V	1 mV 10 mV 100 mV	± (0.8% of meas. val. + 3 digits)
AC voltage <sup>10, 11, 12</sup>	6.000 V 60.00 V 600.0 V	1 mV 10 mV 100 mV	± (1.0% of meas. val. + 3 digits)
DC current - jaws [A] - jack [µA]	600 A 600 µA	0.1 A 0.1 µA	± (2.0% of meas. val. + 5 digits) ± (1.5% of meas. val. + 5 digits)

<sup>6</sup> Specification is valid for capacitances > 10 nF

<sup>7</sup> Maximum measurement duration is 15 s

<sup>8</sup> Does not include the measurement error of the temperature probe. The specified accuracy is the sum total of the measurement errors of the thermocouple adapter and the testo 770.

<sup>9</sup> The lower measuring ranges are only specified from 5% (does not apply to DC current / AC current measurements with the current probe)

<sup>10</sup> Signal bandwidth 40 Hz to 1 kHz

<sup>11</sup> In the case of a mixed signal (AC + DC), only the purely AC component is taken into account

<sup>12</sup> As the frequency increases (over 400 Hz), the accuracy deteriorates +/- (2.5% of m.v. + 3 digits) for 400Hz to 750Hz / +/- (5.0% of m.v. + 3digits) for 750Hz to 1000Hz

Feature	Measuring range <sup>9</sup>	Resolution	Accuracy
AC current <sup>29</sup> - jaws [A] <sup>13</sup> - jack [ $\mu$ A] <sup>28,31</sup>	600 A 600 $\mu$ A	0.1 A 0.1 $\mu$ A	$\pm$ (2.0% of meas. val. + 5 digits) $\pm$ (1.5% of meas. val. + 5 digits)
Resistance	60.00 Ohm 600.0 Ohm 6.000 kOhm 60.00 kOhm 600.0 kOhm 6.000 MOhm 60.00 MOhm	0.01 Ohm 0.1 Ohm 1 Ohm 10 Ohm 100 Ohm 1 kOhm 10 kOhm	$\pm$ (1.5% of meas. val. + 3 digits)
Continuity alarm	0 to 30 Ohm		
Diode test	yes (0 to 2.5 V)		
Active power	600.0W 6.000 kW 60.00 kW	0.1 mV 0.001kW 0.01kW	$\pm$ 5 % $\pm$ 5 digit, for $I > 10$ A <sup>14</sup>
	600.0 kW	0.1 kW	$\pm$ 10 % $\pm$ 5 digit typical for $10$ A $> I > 2$ A <sup>32</sup>
Ractive power	600.0 VAr	0.1 VAr	$\pm$ 5 % $\pm$ 5 digit, bei $I > 10$ A <sup>32</sup>
	6.000 kVAr 60.00 kVAr 600.0 kVAr	0.001 kVAr 0.01 kVAr 0.1 kVAr	$\pm$ 10 % $\pm$ 5 digit typical for $10$ A $> I > 2$ A <sup>32</sup>
Apparent power	600.0 VA 6.000 kVA 60.00 kVA 600.0 kVA	0.1 VA 0.001 kVA 0.01 kVA 0.1 kVA	$\pm$ 1 digit <sup>32</sup>
Power for DC/voltage	600.0 W 6.000 kW 60.00 kW 600.0 kW	0.1 W 0.001 kW 0.01 kW 0.1 kW	$\pm$ 1 digit <sup>32</sup>
Power factor	-1.00 to +1.00	0.01	$\pm$ 5 % $\pm$ 5 digit, for $I > 10$ A <sup>32</sup> $\pm$ 10 % $\pm$ 5 digit typical for $10$ A $> I > 2$ A <sup>32</sup>
Capacitance measurement	6.000 nF <sup>15</sup>	0.001 nF	$\pm$ (10% of meas. val. + 25 digits)
	60.00 nF	0.01 nF	$\pm$ (2% of meas. val. + 10 digits)

<sup>13</sup> Frequency of AC currents up to 400 Hz<sup>14</sup> Specified measuring accuracy levels for the current and voltage measurement must also be taken into account.<sup>15</sup> Accuracy valid for capacitance values  $>2$  nF

Feature	Measuring range <sup>9</sup>	Resolution	Accuracy
	600.0 nF	0.1 nF	± (1.5% of meas. val. + 5 digits)
	6.000 µF	0.001 µF	± (1.5% of meas. val. + 5 digits)
	60.00 µF	0.01 µF	± (1.5% of meas. val. + 5 digits)
	600.0 µF	0.1 µF	± (2% of meas. val. + 10 digits)
	6.000 mF	1.0 µF	± 10% typically
	60.00 mF <sup>16</sup>	10.0 µF	± 10% typically
Frequency with voltage/current <sup>17</sup>	99.99 Hz 999.9 Hz 9.999 kHz	0.01 Hz 0.1 Hz 1 Hz	± (0.1% + 1 digits)
Temperature with adapter <sup>18</sup>	-20 to 500 °C	0.2 °C	-20 to 0 °C ± 2 °C 0 to 99.99 °C ± 1 °C 100 to 249.99 °C ± 1.5% >250 °C ± 2%

Figures correspond to +23 °C ± 5 °C at <80% rel. humidity. Temperature coefficient: 0.15 x specified accuracy per 1 °C (<18 °C and >28 °C)

### 9.3 Bluetooth module (testo 770-3 only)



testo 770-3 only

The use of the wireless module is subject to the regulations and stipulations of the respective country of use, and the module may only be used in each case in countries for which a country certification has been granted.

The user and every owner undertake to adhere to these regulations and prerequisites for use, and acknowledge that the re-sale, export, import, etc. in particular in, to or from countries without wireless permits, is their responsibility.

<sup>16</sup> Maximum measurement duration is 13.2 s

<sup>17</sup> Frequency measurement is not specified for alternating currents or voltages below 3% of the smallest respective measuring range

<sup>18</sup> Does not include the measurement error of the temperature probe. The specified accuracy is the sum total of the measurement errors of the thermocouple adapter and the testo 770



## 10 Tips and assistance

### 10.1 Questions and answers

Question	Possible causes/solution
<b>OL</b>	The reading exceeds the measuring range upper limit > Check input value and change if necessary.
<b>dISC</b> (testo 770-3 only)	The capacitor to be tested still contains charge. > Discharge capacitor properly and carry out the test again.
<b>OPEn</b>	No connection to the probe tips during the RCDC measuring mode. > Establish a connection to the measurement object.

If we have not been able to answer your question, please contact your dealer or Testo Customer Service. For contact details, please visit [www.testo.com/service-contact](http://www.testo.com/service-contact).





### 10.2 Accessories and spare parts

Probe and other assemblies are appropriately rated for measurement category III or IV and have a suitable voltage rating for the circuit to be measured.

## 11 Protecting the environment

- > Dispose of faulty rechargeable batteries/spent batteries in accordance with the valid legal specifications.
- > At the end of its useful life, send the product to the separate collection for electric and electronic devices (observe local regulations) or return the product to Testo for disposal.

## Approval and Certification

Product	testo 770-3	
Mat.-No.	0590 7703	
Country	Comments	
Australia		E 1561
Canada	IC ID: 6127B-2016T7703 IC Warnings	
Europa + EFTA	 <b>EU countries:</b> Belgium (BE), Bulgaria (BG), Denmark (DK), Germany (DE), Estonia (EE), Finland (FI), France (FR), Greece (GR), Ireland (IE), Italy (IT), Latvia (LV), Lithuania (LT), Luxembourg (LU), Malta (MT), Netherlands (NL), Austria (AT), Poland (PL), Portugal (PT), Romania (RO), Sweden (SE), Slovakia (SK), Slovenia (SI), Spain (ES), Czech Republic (CZ), Hungary (HU), United Kingdom (GB), Republic of Cyprus (CY).  <b>EFTA countries:</b> Iceland, Liechtenstein, Norway, Switzerland	
Turkey	Authorized	
USA	FCC ID: WAF-2016T770-3 FCC Warnings	
China	CMIIT ID: 2016DJ3471	
South Korea	 R-CMI-TTT-770-3 KCC Warning	
South Africa	ICASA ID: TA-2016/1743	
Japan	 005-101346 Japan Information	

<p>Brasil</p>	 <p>04695-16-04701</p> <p><i>Este equipamento opera em caráter secundário, isto é, não tem direito à proteção contra interferência prejudicial, mesmo de estações do mesmo tipo e não pode causar interferência a sistemas operando em caráter primário.</i></p>												
<p>Bluetooth SIG List</p>	<table border="1"> <thead> <tr> <th>Feature</th> <th>Values</th> </tr> </thead> <tbody> <tr> <td>Bluetooth Range</td> <td>&lt;20 m (free field)</td> </tr> <tr> <td>Bluetooth type</td> <td>LSD Science &amp; Technology Co., Ltd L Series BLE module (08 May 2013) based on TI CC254X chip</td> </tr> <tr> <td>Qualified Design ID</td> <td>B016552</td> </tr> <tr> <td>Bluetooth radio class</td> <td>Class 3</td> </tr> <tr> <td>Bluetooth company</td> <td>10274</td> </tr> </tbody> </table>	Feature	Values	Bluetooth Range	<20 m (free field)	Bluetooth type	LSD Science & Technology Co., Ltd L Series BLE module (08 May 2013) based on TI CC254X chip	Qualified Design ID	B016552	Bluetooth radio class	Class 3	Bluetooth company	10274
Feature	Values												
Bluetooth Range	<20 m (free field)												
Bluetooth type	LSD Science & Technology Co., Ltd L Series BLE module (08 May 2013) based on TI CC254X chip												
Qualified Design ID	B016552												
Bluetooth radio class	Class 3												
Bluetooth company	10274												
	<p>The product is certified for the US and Canadian markets, in accordance with the applicable American and Canadian safety standards.</p>												

#### IC Warnings

##### **RSS-Gen & RSS-247 statement:**

This device complies with Industry Canada licence-exempt RSS standard(s).

Operation is subject to the following two conditions:

- (1) this device may not cause interference, and
- (2) this device must accept any interference, including interference that may cause undesired operation of the device.

Le présent appareil est conforme aux CNR d'Industrie Canada applicables aux appareils radio exempts de licence.

L'exploitation est autorisée aux deux conditions suivantes :

- (1) l'appareil ne doit pas produire de brouillage, et
- (2) l'utilisateur de l'appareil doit accepter tout brouillage radioélectrique subi, même si le brouillage est susceptible d'en compromettre le fonctionnement.

#### FCC Warnings

Information from the FCC (Federal Communications Commission)

##### **For your own safety**

Shielded cables should be used for a composite interface. This is to ensure continued protection against radio frequency interference.

##### **FCC warning statement**

This equipment has been tested and found to comply with the limits for a Class C digital device, pursuant to Part 15 of the FCC Rules. These limits are designed to provide reasonable protection against harmful interference in a residential installation. This equipment generates, uses and can radiate radio frequency energy and, if not installed and used in accordance with the instructions, may cause harmful interference to radio communications. However, there is no guarantee that interference will not occur in a

particular installation. If this equipment does cause harmful interference to radio or television reception, which can be determined by turning the equipment off and on, the user is encouraged to try to correct the interference by one or more of the following measures:

- Reorient or relocate the receiving antenna.
- Increase the separation between the equipment and receiver.
- Connect the equipment into an outlet on a circuit different from that to which the receiver is connected.
- Consult the dealer or an experienced radio/TV technician for help.

### **Caution**

Changes or modifications not expressly approved by the party responsible for compliance could void the user's authority to operate the equipment. Shielded interface cable must be used in order to comply with the emission limits.

### **Warning**

This device complies with Part 15 of the FCC Rules. Operation is subject to the following two conditions:

- (1) this device may not cause harmful interference, and
- (2) this device must accept any interference received, including interference that may cause undesired operation.

### Japan Information

当該機器には電波法に基づく、技術基準適合証明等を受けた特定無線設備を装着している。

### KCC Warning

해당 무선 설비는 운용 중 전파혼신 가능성이 있음.





**Testo SE & Co. KGaA**

Celsiusstr. 2

79822 Titisee-Neustadt

Germany

Tel.: +49 7653 681-0

E-Mail: [info@testo.de](mailto:info@testo.de)

[www.testo.com](http://www.testo.com)